

Varenummer: 2310431050S
Beskrivelse: E+G Stilleben
LX.40-SW17-M12X102-S

Mål

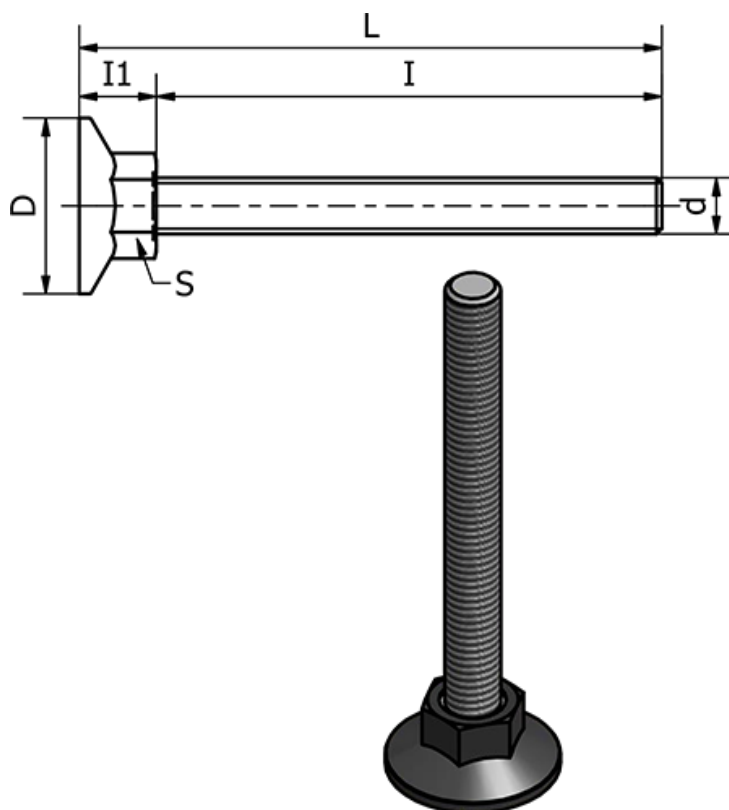

d	= M12
D	= 40
I	= 102
I1	= 13
L	= 114.5
Max statisk belastning (N)	= 5000
S	= 17
Type	= Forzinket

Vægt (g) = -